

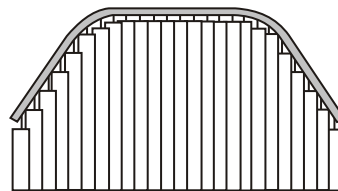

Template Guide for Curved & Arch Headrails

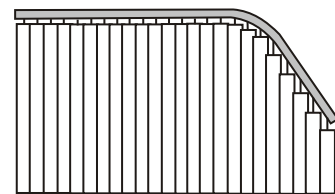

BAY CURVE TEMPLATE GUIDELINES

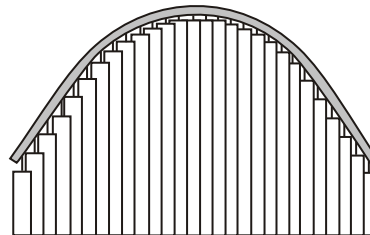
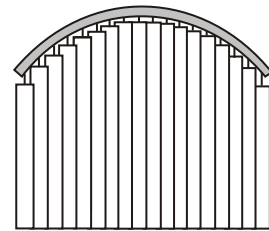
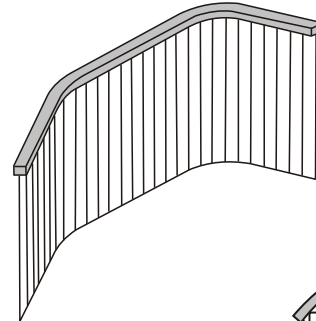
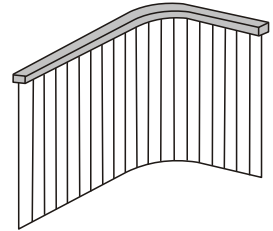
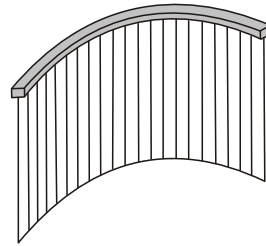

3. TEMPLATE MAKING

Use a 40# craft paper. For a larger window, you may have to use multiple pieces taped together.

Lay the paper onto the window frame.

Indicate whether the template was marked from above or below, i.e. looking up or looking down.

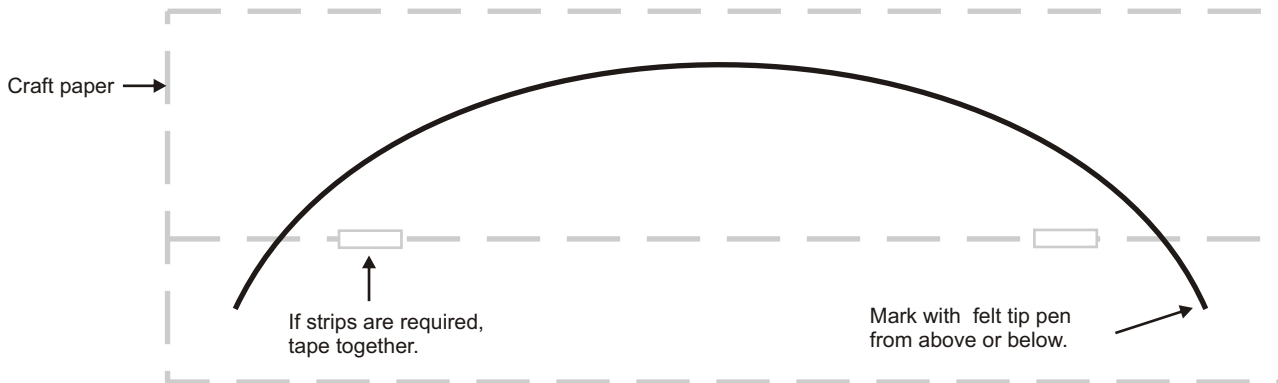

4. WINDOW CLEARANCE

Measure the window frame or wall and give us the dimension of how far to come in with the track, i.e. Allow (A) 2" to center of the track or allow (B) 2" to the back track.

NOTE: Additional clearance is necessary to clear the window sill or crank handles.

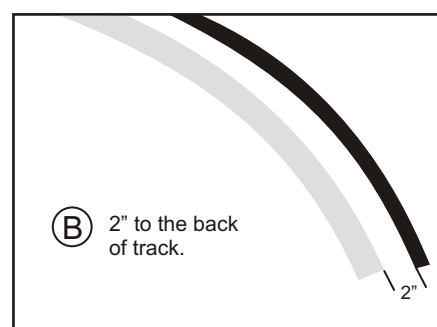
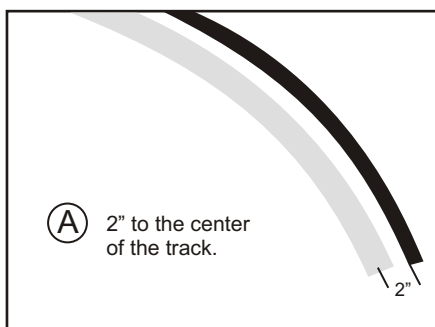

BAY CURVE TEMPLATE GUIDELINES

Key: Headrail Glass or Window

5. LIGHT GAPS

Be sure to mark where you want the track to stop in relation to the window. This step is important to ensure minimal light gaps at the sides of the blind. Provide a small sketch on the template or on a separate sheet stapled to the template.

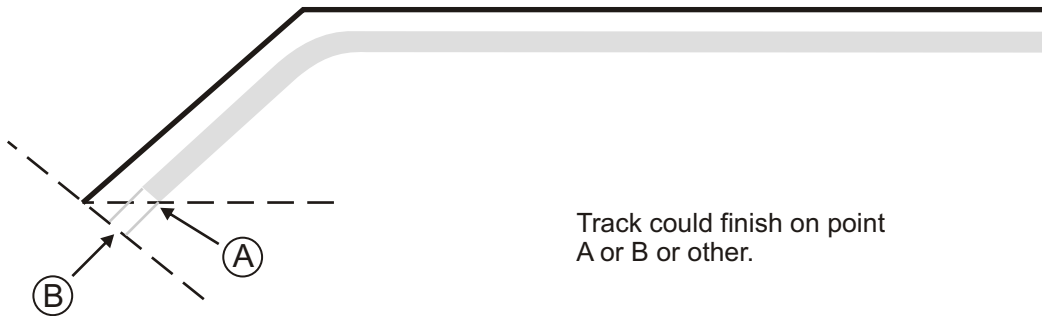

6. FINISHED TEMPLATE must include measurements A, B, C and the drawing of the track showing the exact ending points and the headrail layout.

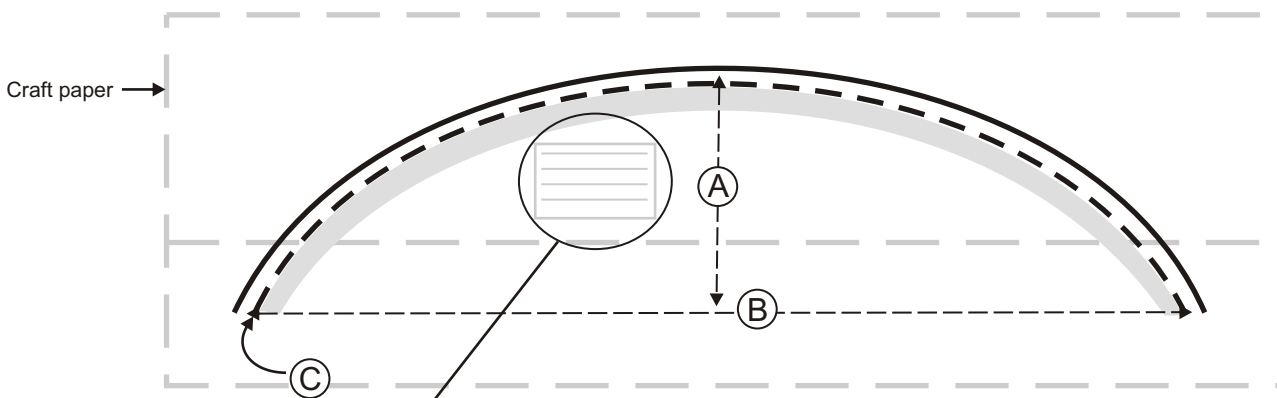

**SEE TEMPLATE GUIDE
FOR INFORMATION**

*** See last page of guide**

VERY IMPORTANT

Finished template **MUST** include the information listed in Template Guide (see last page of Guide)

BAY CURVE TEMPLATE GUIDELINES



7. CHECK YOUR MEASUREMENTS

When making a template always give a check measurement across the start and end points of the template. (A)*

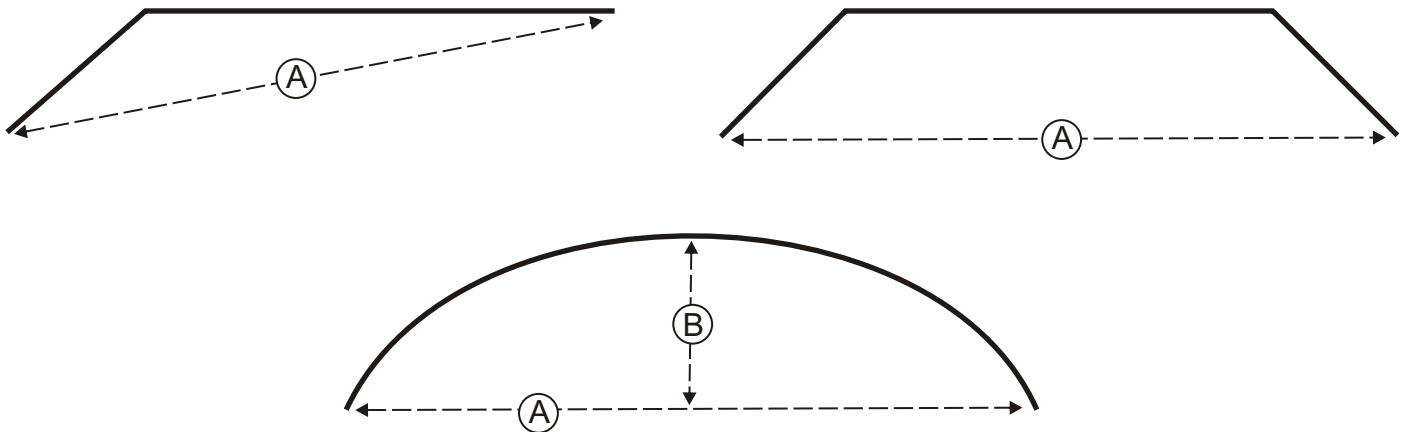

In the case of a curve, give us measurement (B) as well.

NOTE: This is the dimension across the window frame/wall, not the track.

Pay attention to the depth of the pocket (if there is one). Be sure that you get the track and motor in, especially when using multiple tracks, i.e. Sheer and over-drape IllumaSheer_{tm}.

Pay attention to the minimum radius of the track. The system and the radius of the track will determine the fit in the window (tight or gradual), i.e. In this example the track appears curved and does not show the more pronounced angles of the window.



On very tight radiuses, this type of installation may be necessary.

BAY CURVE MEASURING INFORMATION

Key: Headrail Glass or Window

8. HEADRAIL SIZE IN RELATIONSHIP TO WINDOW DIMENSIONS

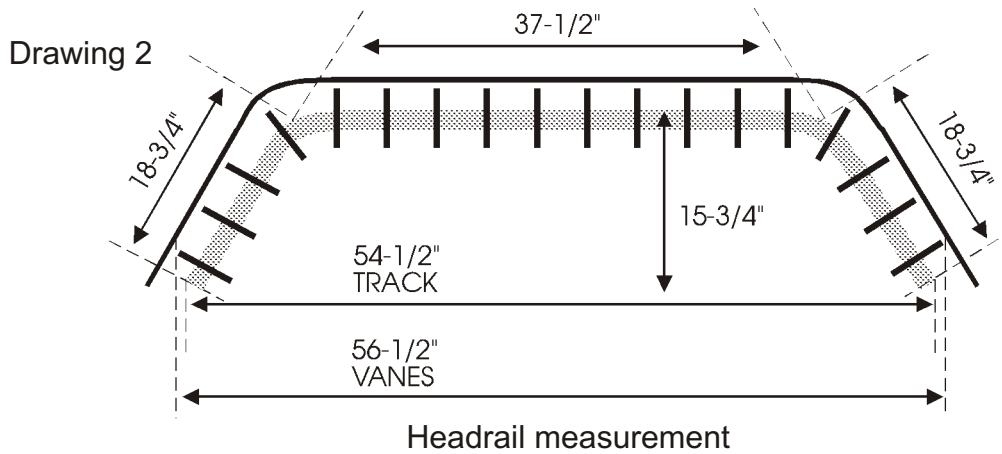
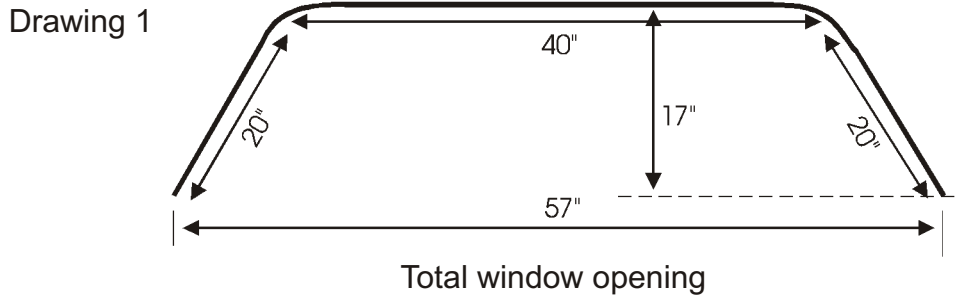
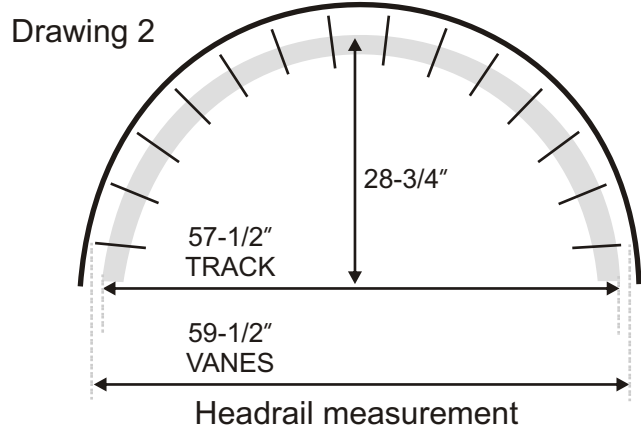
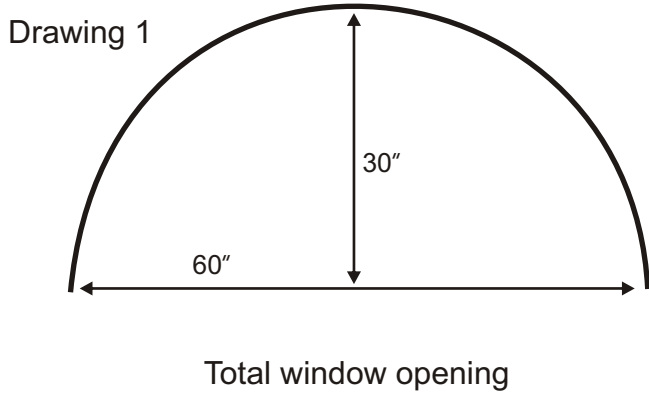

NOTE: Additional clearance may be necessary for window sills, crank handles, etc.

ARCHED MEASURING INFORMATION

It is important that we receive the correct details and information to enable us to bend your arched headrail accurately. The following is the information you should include with your order.

Key:	 Headrail	 Glass or Window
------	--	---

1. REQUIRED MEASUREMENTS

- A. Height of radius
- B. Length of radius

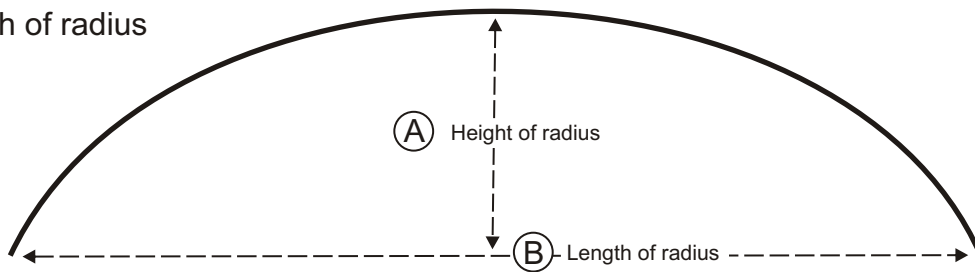

2. DEFINITIONS

- A. Top of Headrail - area where bracket snaps on (point furthest from the floor).
- B. Bottom of Headrail - area where hooks come out.
- C. Arc Length of Headrail - running linear length of the *top of headrail*.

ARCHED HEADRAIL GUIDELINES:	
Minimum radius	
with all size vanes	19-3/4"
Maximum headrail length	220"

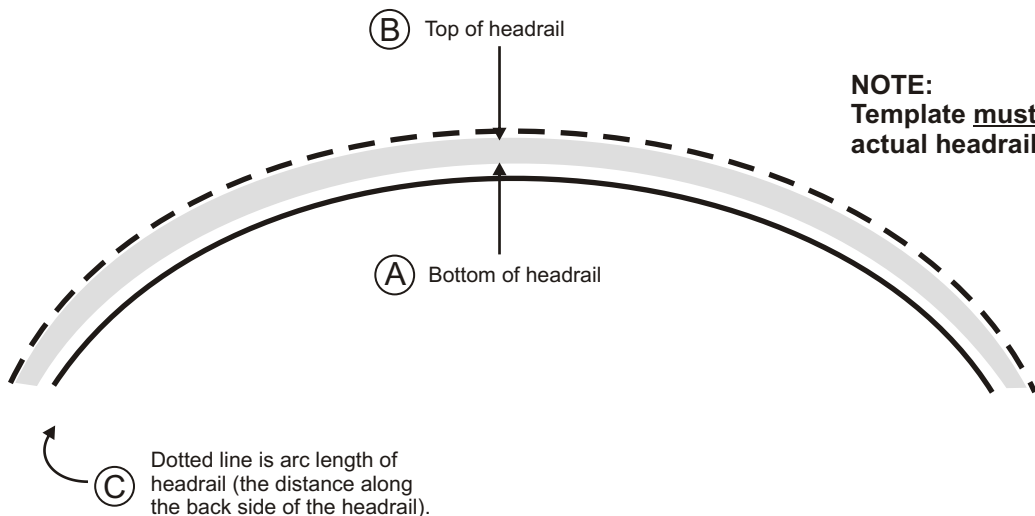

NOTE:
Template must show actual headrail layout.

ARCHED TEMPLATE GUIDELINES



3. TEMPLATE MAKING

Use a 40# craft paper. For a larger window, you may use multiple pieces taped together.

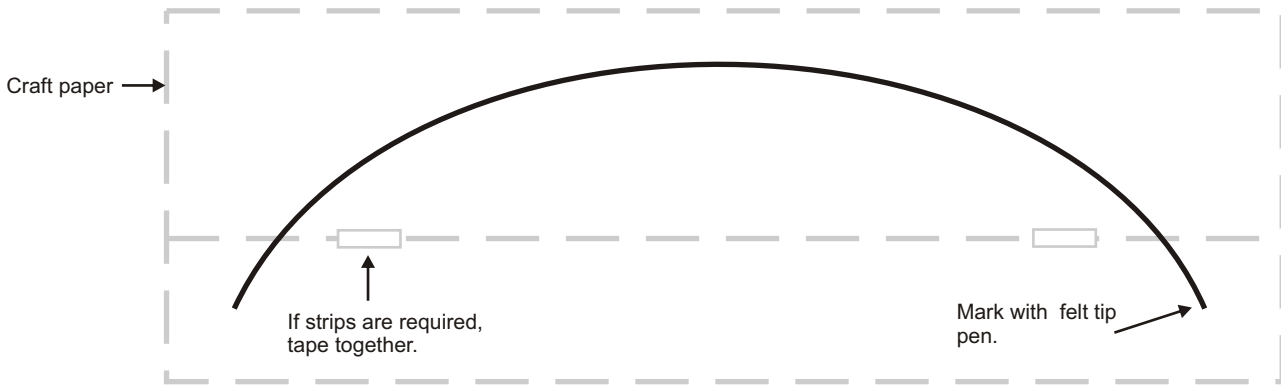

4. FINISHED TEMPLATE must include measurements A, B, C and the drawing of the track showing the exact ending points and the headrail layout.

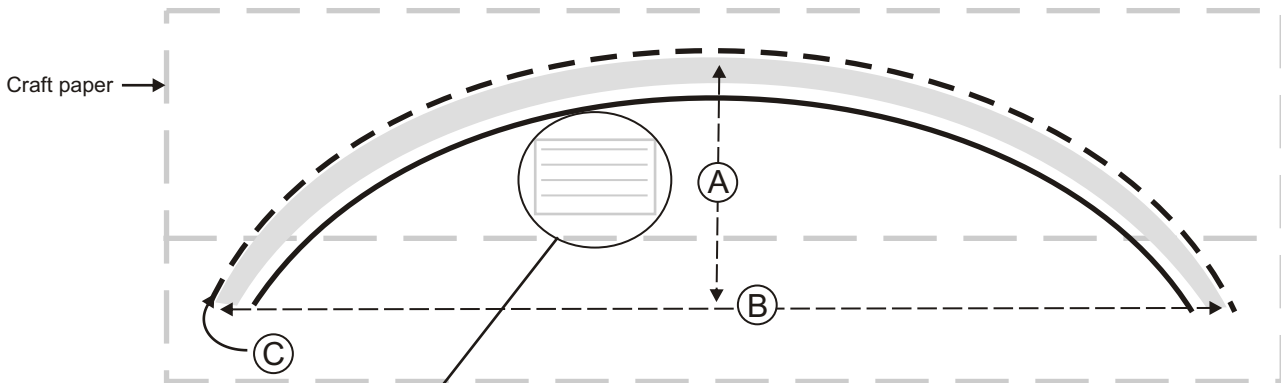

**SEE TEMPLATE GUIDE
FOR INFORMATION**

*** See last page of guide**

VERY IMPORTANT
Finished template MUST include the information listed in Template Guide (see last page of guide)

ARCHED MEASURING INFORMATION

Key:	Headrail	Glass or Window
------	----------	-----------------

5. OUTSIDE MOUNT *“Recommended”* HEADRAIL SIZE IN RELATIONSHIP TO WINDOW DIMENSIONS

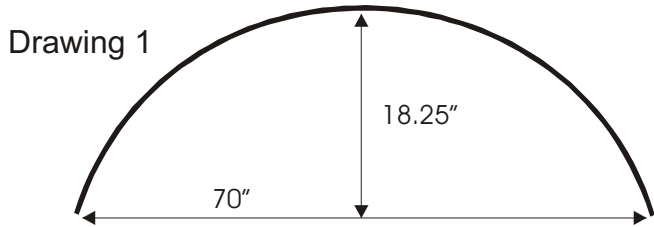

Total window opening

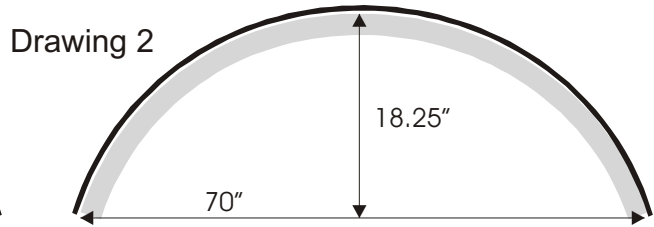

Headrail measurement

For a custom fit, a 4" clearance is suggested to cut down light gap when the vertical is closed. NOTE: The minimal clearance for brackets is 2-1/2".

Drawing 3

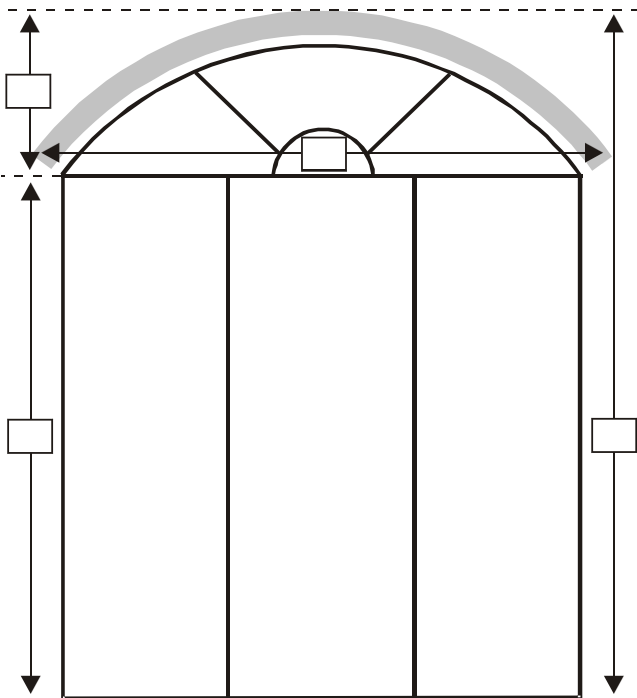

Measurements required for outside mount for arched headrails with floor length vanes.

Drawing 4

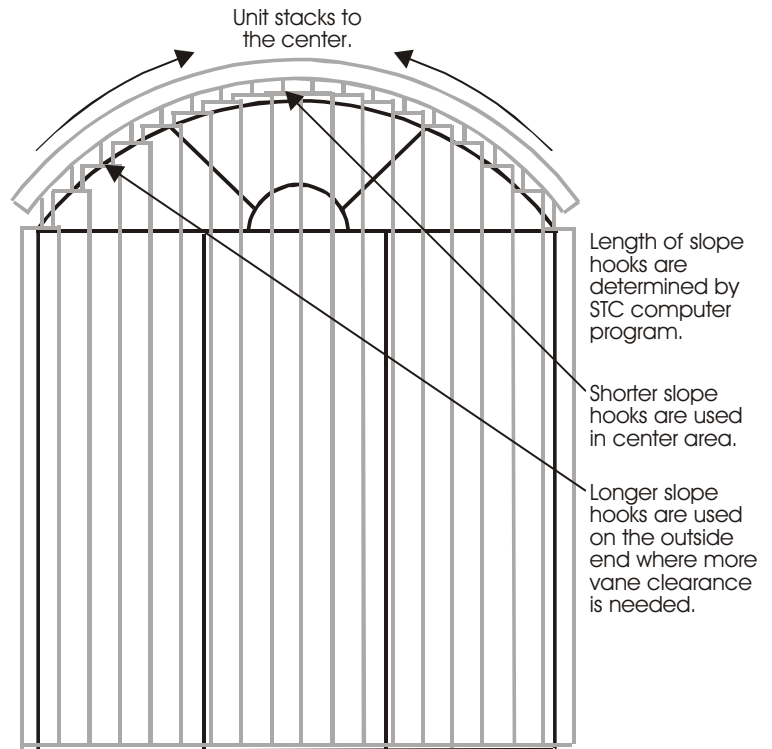

FINAL FIT - NOTE: Template needed for arched area only.

ARCHED MEASURING INFORMATION

Key:	 Headrail	 Glass or Window
------	--	---

6. INSIDE MOUNT *“Not Recommended”* HEADRAIL SIZE IN RELATIONSHIP TO WINDOW DIMENSIONS

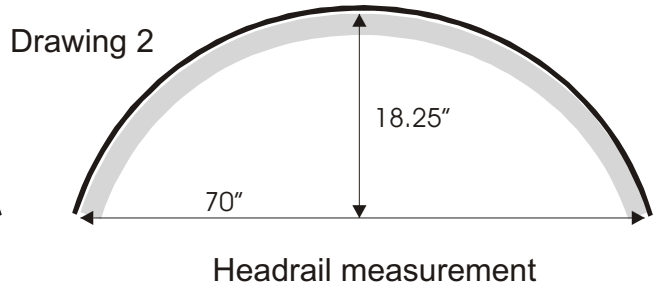
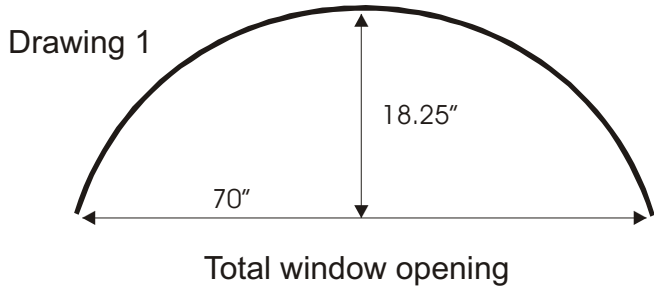

This measurement will be exactly the same as the total window opening.

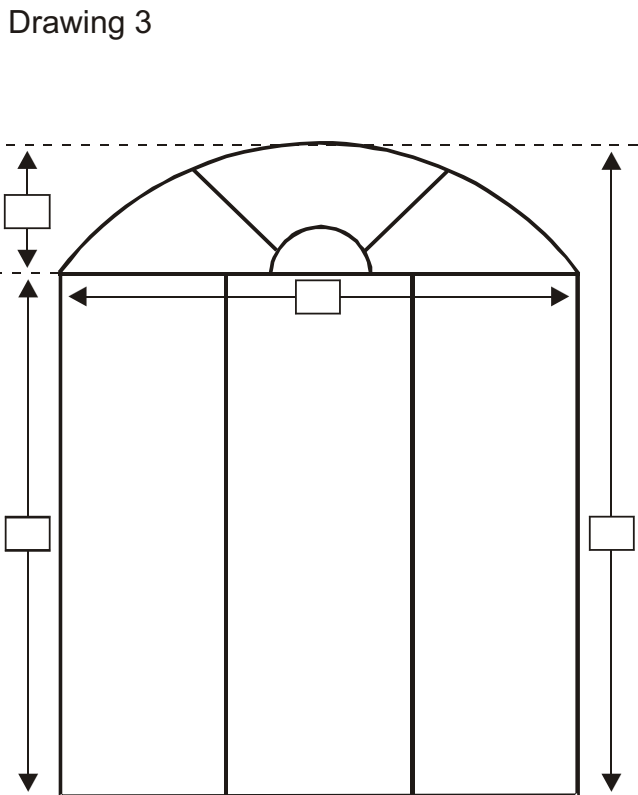

Measurements required for inside mount for arched headrails with floor length vanes.

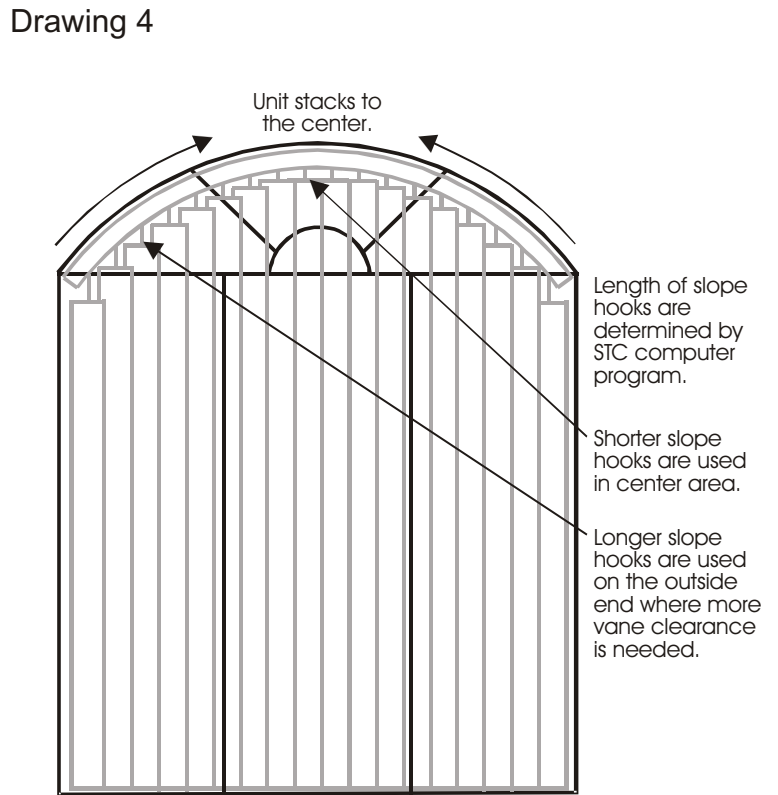

FINAL FIT - NOTE: Template needed for arched area only.

ARCHED MEASURING INFORMATION

Key:	 Headrail	 Glass or Window
------	--	---

7. IRREGULAR BENDING - OUTSIDE MOUNT

Slope/straight headrail combination required measurements

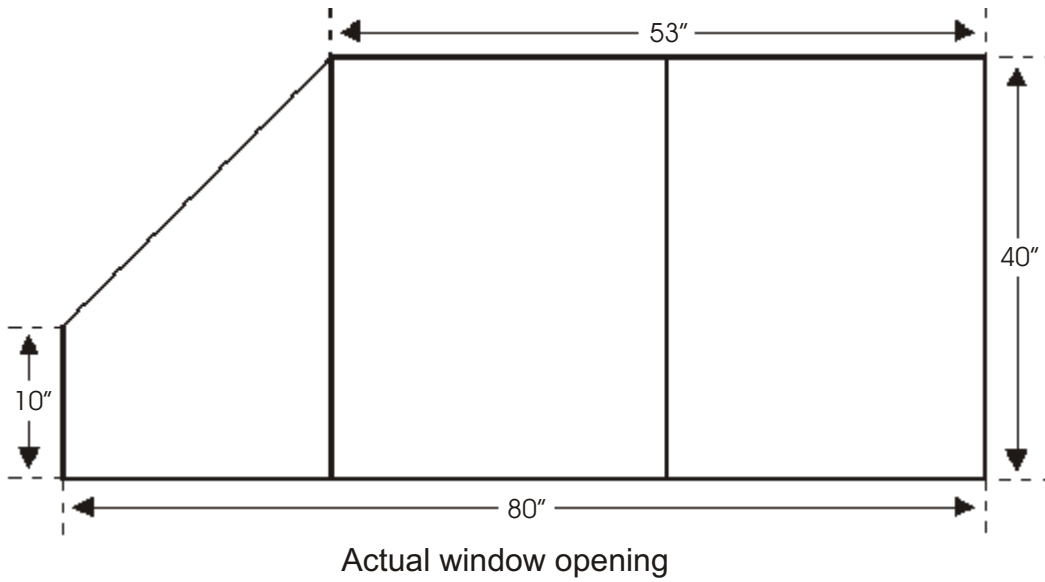

NOTE: The headrail radius curve is not a sharp angle.

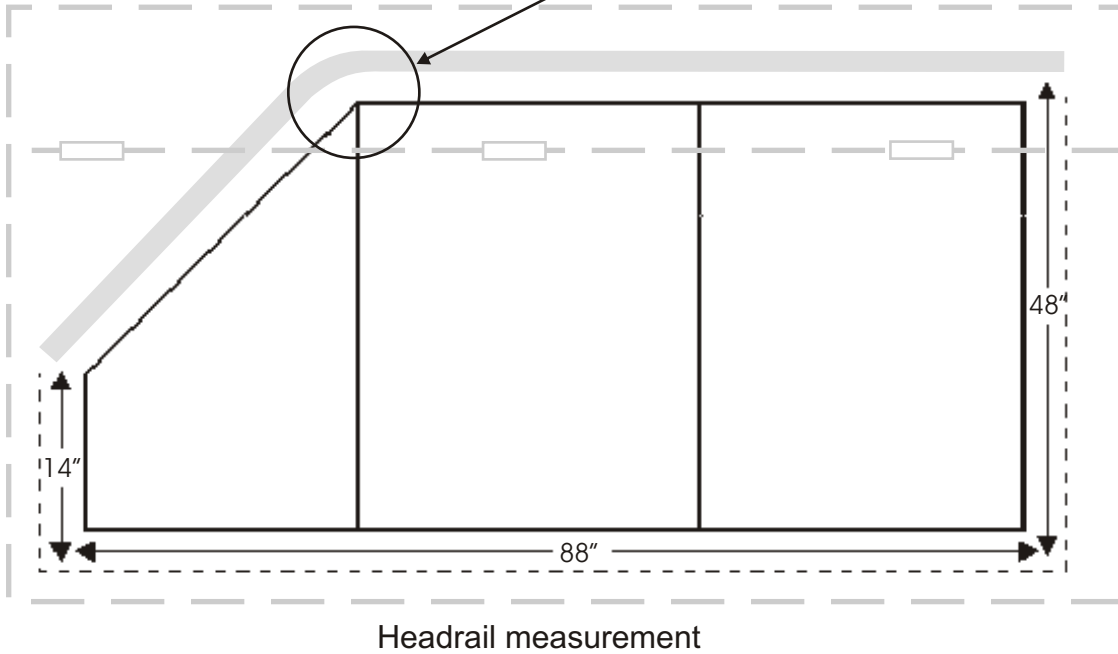

ARCHED MEASURING INFORMATION

Key:  Headrail  Glass or Window

8. TROUBLE SHOOTING DIFFICULT ARCHED WINDOWS

Possible light gap problems on **INSIDE MOUNT** blinds.

For areas where privacy and outside light control are required, the manufacturer suggests **OUTSIDE MOUNT** installations.

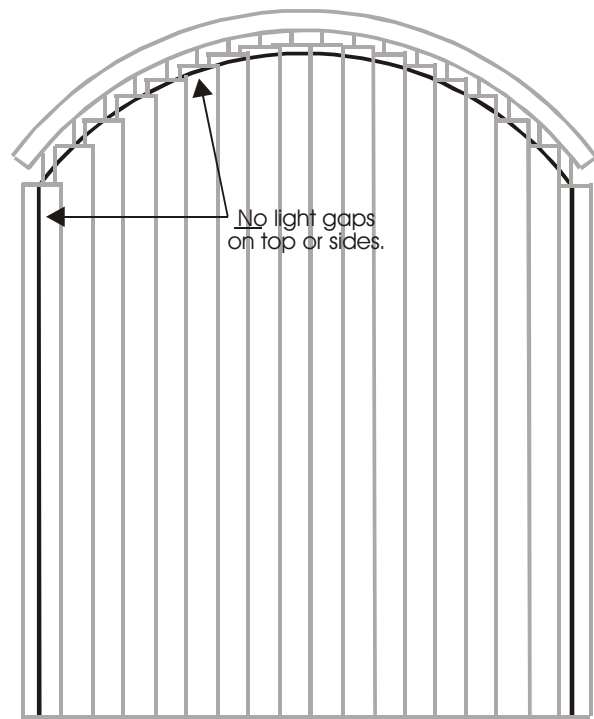
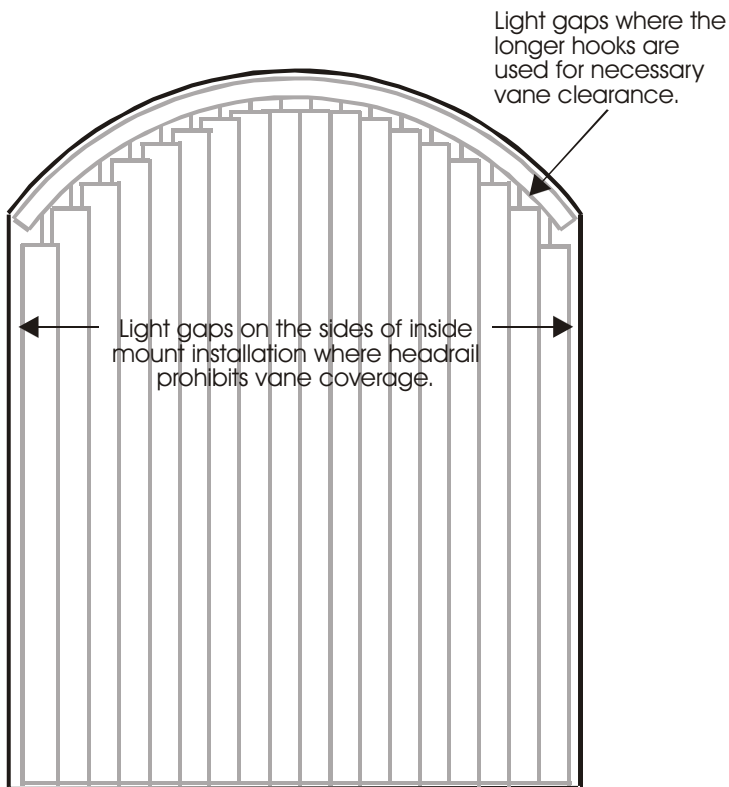

The manufacturer also suggests outside installation for a very tight radius or small half circle.

Date: _____

Company: _____ Account Number: _____

Contact person: _____ Phone Number: _____

PRODUCT TYPE: _____ Curve (Horizontal bend) _____ Arch (Vertical bend)

QUANTITY: _____ **Side mark:** _____

**** Direction in which carriers face MUST be written on template**

Mount: _____ Inside (IB) _____ Outside (OB)

Control end: _____ Right _____ Left **Cord drop:** _____

STACK OPTIONS:

Curve (Horizontal bend)

_____ Right _____ Left _____ Split (center opening)

_____ Center (all vanes go to center) _____ Rotation Only

-Arch (Vertical bend) INSIDE MOUNT NOT RECOMMENDED!

YOU WILL HAVE 1" LIGHT GAPS ON EACH END OF BLIND!!!

_____ Center (all vanes go to center) _____ Rotation Only



Decomatic® Warranty

Sunteca Systems, Inc. ("Company") warrants that its Products will be free from defects in materials and workmanship, under normal use and service and subject to the conditions set forth below, for the following respective time periods:

HEAD RAIL: LIFETIME LIMITED WARRANTY

Company warrants that its Head rail sold hereunder will substantially conform to the applicable specifications and will be free from defects in material and workmanship for the life of the Head rail, under normal and proper use and service.

BLIND LOUVERS/FABRIC/PVC: 3 YEAR LIMITED WARRANTY

Company warrants that its blind louvers, or fabric, or PVC sold hereunder will substantially conform to the applicable specifications and will be free from defects in material and workmanship for a period of three (3) years after date of purchase, under normal and proper use and service.

ELECTRICAL COMPONENTS: 2 YEAR LIMITED WARRANTY

Company warrants that its Electrical components sold hereunder will substantially conform to the applicable specifications and will be free from defects in material and workmanship for a period of two (2) years after the date of purchase, under normal and proper use and service.

WARRANTY LIMITATION. This limited warranty and remedies for breach of warranty extend only to the ultimate owner at the original site of installation and do not cover, and Company shall not be liable for, (i) abnormal wear and tear or damage caused by improper installation, maintenance or use contrary to the instructions published by Company (ii) storage of Products in a wet or damp area or unprotected from weather and other job conditions (iii) any cause beyond the control of Company, including without limitation conditions caused by movement, settlement or structural defects of building in which the Products are installed, fire, wind, hail, flood, lightning or other acts of God, intentional acts, accidents, negligence or exposure to harmful chemicals, pollutants or other foreign matter or energy, or (iv) repair or damage caused by anyone except personnel authorized by Company. Products repaired or replaced and designs corrected under warranty are warranted only for the remainder of the original warranty period if a time limitation has been given. Any general product literature is for illustrative purposes only and does not amount to a warranty of any kind. Purchaser accepts full responsibility for the selection of the Products to achieve intended results.

THIS LIMITED WARRANTY AS SET FORTH HEREIN IS STRICTLY LIMITED TO ITS TERMS AND IS IN LIEU OF ALL OTHER WARRANTIES, GUARANTEES, EXPRESS OR IMPLIED, ARISING BY OPERATION OF LAW, COURSE OF DEALING, USAGE OF TRADE OR OTHERWISE. ANY IMPLIED WARRANTIES INCLUDING BUT NOT LIMITED TO ANY IMPLIED WARRANTIES OF MERCHANTABILITY OR FITNESS FOR A PARTICULAR PURPOSE SHALL BE LIMITED IN DURATION TO THE WARRANTY PERIODS OF TIME SET FORTH ABOVE.

REMEDY. PURCHASER'S SOLE AND EXCLUSIVE REMEDY UNDER THIS LIMITED WARRANTY OR ANY OTHER WARRANTY (INCLUDING ANY IMPLIED WARRANTY), AND COMPANY'S ONLY OBLIGATION FOR BREACH OF WARRANTY FOR PRODUCTS FURNISHED HEREUNDER, SHALL BE, AT COMPANY'S OPTION, TO REPAIR OR REPLACE THE DEFECTIVE ITEM(S) OR PART(S) WHICH FAIL WITHIN THE DESIGNATED WARRANTY TIME PERIOD, FREE OF CHARGE, provided that Purchaser promptly give notice, but no later than 30 days after defect(s) is discovered, to Company of such failure. In the event Purchaser claims that the Products are defective, Purchaser must return such Products to Company, prepaid FOB, to allow Company to examine the Products to determine if such Products are defective. In addition, upon Company's request, Purchaser must allow Company's personnel access and permission to inspect the Products at the site of installation or use. NOTWITHSTANDING THIS WARRANTY, UNDER ALL CIRCUMSTANCES, PURCHASER IS RESPONSIBLE FOR THE COSTS OF REMOVAL, INSTALLATION OR REINSTALLATION OF THE PRODUCT.

DISCLAIMER: LIMITATION OF LIABILITY ' TIME FOR CLAIMS. Purchaser understands and agrees that COMPANY SHALL NOT BE LIABLE FOR INCIDENTAL, SPECIAL, INDIRECT OR CONSEQUENTIAL OR OTHER SIMILAR DAMAGES including but not limited to loss of profit or revenues, damage for loss of the use of the products, damages due to delay, damage to property, claims of third parties, including personal injury or death suffered as a result of use of products or failure of Company to warn, or to adequately warn, against the dangers of the products or to instruct, or adequately instruct, about the safe and proper use of the products, whether or not the Company has been advised to the potential for such damages. The total liability of Company to Purchaser from any cause whatsoever, whether arising under contract, warranty, tort (including negligence), strict liability, products liability or any other theory of liability, will be limited to the lesser of Purchaser's actual damages or the purchase price paid to Company for the products that are the subject of Purchaser's claim. However, this limitation of liability does not apply to damages resulting from personal injury caused by Company's negligence. All claims against Company must be brought within one year after the cause of action arises, and Purchaser expressly waives any statute of limitations which might apply by operation of law or otherwise.

COMPANY SHALL NOT BE LIABLE FOR ANY DAMAGE OR PENALTIES WHATSOEVER, WHETHER, DIRECT, INDIRECT, INCIDENTAL, SPECIAL OR CONSEQUENTIAL, FOR ACTIONS AND OMISSIONS RESULTING FROM COMPANY'S FAILURE TO DELIVER OR DELAY IN DELIVERY FOR ANY REASON.

CLAIMS FOR WARRANTY SERVICE

To obtain warranty service, Purchaser must notify company and the dealer which sold the product in writing of the nature of the problem. In the written notice, Purchaser must include its name, address, telephone number, a description of the problem and the date on which the problem first occurred. A bill of sale, canceled check, receipt or other proof of purchase also must be provided to verify the date of purchase and the identity of the Purchaser. In some cases, Company may require Purchaser to ship the defective part(s), transportation or other related charges prepaid, to the nearest warranty service factory location. Purchaser must contact Company and the dealer that sold the Product as soon as possible, but no later than 30 days, after the defect(s) is discovered. If Purchaser has any problems with or questions about warranty service, please write Sunteca Systems, Inc. at Avenue A, Building #2, Leetsdale, PA 15056.

REPLACEMENT PARTS. Replacement parts supplied by Company under this Limited Warranty are not warranted.

RESALE OF PRODUCTS. Upon resale of any Products sold hereunder, Purchaser agrees to extend to its customers no greater warranties than those contained herein and limit its liability and remedies to the same extent as those set forth herein.

SEPARABILITY; INVALIDITY. If any portion of this Limited Warranty shall for any reason be held by a court of competent jurisdiction to be invalid and unenforceable, the valid and enforceable provisions will continue to be given effect and bind parties hereto.